

## LAY-IN PAINTED FLAT-COVER WIREWAY, NEMA TYPE 1



### APPLICATION

This painted wireway features an open design on one side so wires and cables can be laid in safely along the entire run without pulling, a practice that can damage insulation. A variety of lengths and fittings provide design flexibility.

### FEATURES

- Flat cover design
- Open top assembly
- Available with or without knockouts
- Keyhole screw slots on flat covers

### SPECIFICATIONS

- 16 and 14 gauge pre-painted steel covers and bodies

### FINISH

ANSI 61 gray polyester powder paint finish inside and out.

### INDUSTRY STANDARDS

UL 870 Listed; File No. E27524  
 cUL Listed per CSA C22.2 No. 26; File No. E27524

NEMA/EEMAC Type 1  
 IEC 60529

This drawing illustrates how most of the Hoffman NEMA Type I lay-in wireway sections and fittings could be used in an actual wireway run. The covers have been omitted to present the lay-in feature more clearly. Many different sections and fittings can be combined in any configuration desired.

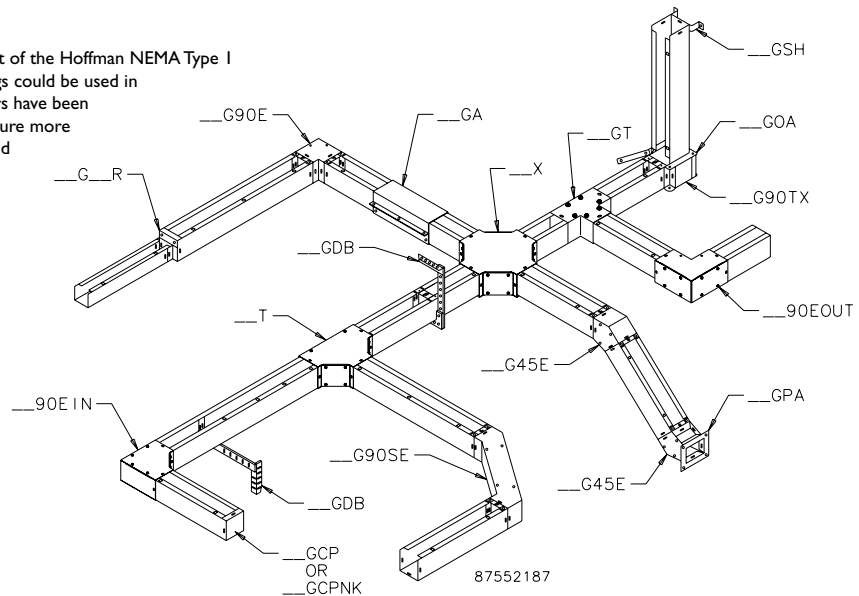

Standard Product Selection Matrix

Description	2.50 x 2.50 in. (64 x 64 mm)	3.00 x 3.00 in. (76 x 76 mm)	4.00 x 4.00 in. (102 x 102 mm)	6.00 x 6.00 in. (152 x 152 mm)	8.00 x 8.00 in. (203 x 203 mm)	10.00 x 10.00 in. (254 x 254 mm)	12.00 x 12.00 in. (305 x 305 mm)
12.00-in. (305-mm) Straight Section with knockouts	F22T112GVPWK	—	F44T112GVPWK	F66T112GVPWK	F88T112GVPWK	—	F1212T112GVPWK
12.00-in. (305-mm) Straight Section without knockouts	F22T112GVP	—	F44T112GVP	F66T112GVP	F88T112GVP	F1010T112GVP	F1212T112GVP
18.00-in. (455-mm) Straight Section without knockouts	—	—	F44T118GVP	F66T118GVP	F88T118GVP	—	—
24.00-in. (610-mm) Straight Section with knockouts	F22T124GVPWK	—	F44T124GVPWK	F66T124GVPWK	F88T124GVPWK	—	F1212T124GVPWK
24.00-in. (610-mm) Straight Section without knockouts	F22T124GVP	—	F44T124GVP	F66T124GVP	F88T124GVP	F1010T124GVP	F1212T124GVP
36.00-in. (914-mm) Straight Section with knockouts	F22T136GVPWK	—	F44T136GVPWK	F66T136GVPWK	F88T136GVPWK	—	F1212T136GVPWK
36.00-in. (914-mm) Straight Section without knockouts	F22T136GVP	—	F44T136GVP	F66T136GVP	F88T136GVP	F1010T136GVP	F1212T136GVP
48.00-in. (1219-mm) Straight Section with knockouts	F22T148GVPWK	—	F44T148GVPWK	F66T148GVPWK	F88T148GVPWK	—	F1212T148GVPWK
48.00-in. (1219-mm) Straight Section without knockouts	F22T148GVP	—	F44T148GVP	F66T148GVP	F88T148GVP	F1010T148GVP	F1212T148GVP
60.00-in. (1524-mm) Straight Section with knockouts	F22T160GVPWK	—	F44T160GVPWK	F66T160GVPWK	F88T160GVPWK	—	F1212T160GVPWK
60.00-in. (1524-mm) Straight Section without knockouts	F22T160GVP	F33T160GVP	F44T160GVP	F66T160GVP	F88T160GVP	F1010T160GVP	F1212T160GVP
72.00-in. (1829-mm) Straight Section with knockouts	—	—	F44T172GVPWK	F66T172GVPWK	—	—	—
72.00-in. (1829-mm) Straight Section without knockouts	—	—	F44T172GVP	F66T172GVP	F88T172GVP	F1010T172GVP	—
120.00-in. (3048-mm) Straight Section with knockouts	F22T1120GVPWK	—	F44T1120GVPWK	F66T1120GVPWK	F88T1120GVP	—	—
120.00-in. (3048-mm) Straight Section without knockouts	F22T1120GVP	F33T1120GVP	F44T1120GVP	F66T1120GVP	F88T1120GVP	F1010T1120GVP	F1212T1120GVP
90° Flush Tee	F22GT	F33GT	F44GT	F66GT	F88GT	F1010GT	F1212GT
Sweep Tee	F22T	—	F44T	F66T	F88T	F1010T	F1212T
Cross Fitting	F22X	—	F44X	F66X	F88X	F1010X	F1212X
90° Sweep Elbow	F22G90SE	—	F44G90SE	F66G90SE	F88G90SE	F1010G90SE	F1212G90SE
90° Elbow-Tee-Cross	F22G90TX	F33G90TX	F44G90TX	F66G90TX	F88G90TX	F1010G90TX	F1212G90TX
90° Elbow	F22G90E	F33G90E	F44G90E	F66G90E	F88G90E	F1010G90E	F1212G90E
90° Elbow Outside Opening	F2290EOUT	—	F4490EOUT	F6690EOUT	F8890EOUT	F101090EOUT	F121290EOUT
90° Elbow Inside Opening	F2290EIN	—	F4490EIN	F6690EIN	F8890EIN	F101090EIN	F121290EIN
45° Elbow	F22G45E	F33G45E	F44G45E	F66G45E	F88G45E	F1010G45E	F1212G45E
Telescope Fitting <sup>a</sup>	F22GA	—	F44GA	F66GA	F88GA	F1010GA	F1212GA
Open Adapter	F22GOA	—	F44GOA	F66GOA	F88GOA	F1010GOA	F1212GOA
Panel Adapter	F22GPA	F33GPA	F44GPA	F66GPA	F88GPA	F1010GPA	F1212GPA
Closure Plate with knockouts	F22GCP	—	F44GCP	F66GCP	F88GCP	F1010GCP	F1212GCP
Closure Plate without knockouts	F22GCPNK	F33GCPNK	F44GCPNK	F66GCPNK	F88GCPNK	F1010GCPNK	F1212GCPNK
Reducer	—	F33G22R	F44G22R	F66G44R	F88G66R	F1010G88R	F1212G88R
Drop and Bracket Hanger	F22GDB	—	F44GDB	F66GDB	F88GDB	F1010GDB	F1212GDB
Support Hanger	F22GSH	—	F44GSH	F66GSH	F88GSH	F1010GSH	F1212GSH
Universal U-Connector	F22GUC	F33GUC	F44GUC	F66GUC	F88GUC	F1010GUC	F1212GUC
Barrier Kit, bolt-on Each barrier 60.00 in. (1524 mm)	—	F33BK60	F44BK60	F66BK60	F88BK60	—	—

<sup>a</sup>Not UL/cUL listed.

STRAIGHT SECTION

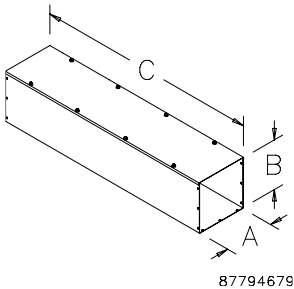

Protects electrical wiring in applications where dust, dirt, oil and water are not serious problems. All sections and fittings are completely open on one side so wires and cables can be laid in along wireway run. No pulling through of wires or cables prevents damage to insulation that often occurs in a pull-through wiring system. Flat cover design allows for mounting flush with walls or ceilings. Keyhole screw slots on flat covers provide easy access.

BULLETIN: F40FC, F40G

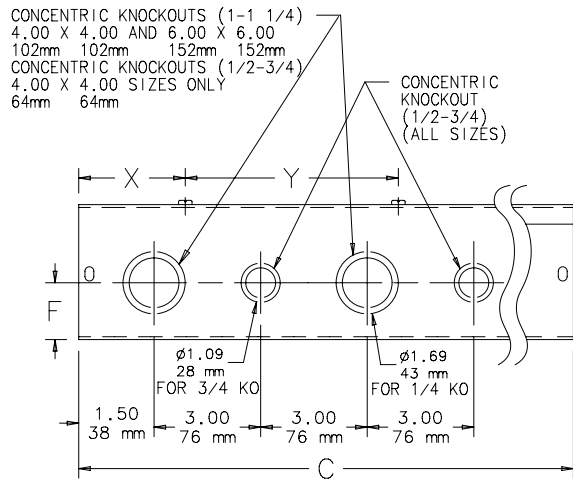

PATTERN REPEATS EVERY 12.00 305 mm

## Straight Sections

Catalog Number	AxBxC in.	AxBxC mm	Number of Knockouts, .50 in.-.75 in.	Number of Knockouts, 1.00 in.-1.25 in.	F (in.)	F (mm)	X (in.)	X (mm)	Y (in.)	Y (mm)
F22T112GVPWK	2.50 x 2.50 x 12.00	64 x 64 x 305	8	—	1.06	27	3.00	76	6.00	152
F22T112GVP	2.50 x 2.50 x 12.00	64 x 64 x 305	—	—	—	—	—	—	—	—
F22T124GVPWK	2.50 x 2.50 x 24.00	64 x 64 x 610	16	—	1.06	27	6.00	152	12.00	305
F22T124GVP	2.50 x 2.50 x 24.00	64 x 64 x 610	—	—	—	—	—	—	—	—
F22T136GVPWK	2.50 x 2.50 x 36.00	64 x 64 x 914	24	—	1.06	27	6.00	152	12.00	305
F22T136GVP	2.50 x 2.50 x 36.00	64 x 64 x 914	—	—	—	—	—	—	—	—
F22T148GVPWK	2.50 x 2.50 x 48.00	64 x 64 x 1219	32	—	1.06	27	6.00	152	12.00	305
F22T148GVP	2.50 x 2.50 x 48.00	64 x 64 x 1219	—	—	—	—	—	—	—	—
F22T160GVPWK	2.50 x 2.50 x 60.00	64 x 64 x 1524	40	—	1.06	27	6.00	152	12.00	305
F22T160GVP	2.50 x 2.50 x 60.00	64 x 64 x 1524	—	—	—	—	—	—	—	—
F22T1120GVPWK	2.50 x 2.50 x 120.00	64 x 64 x 3048	80	—	1.06	27	6.00	152	12.00	305
F22T1120GVP	2.50 x 2.50 x 120.00	64 x 64 x 3048	—	—	—	—	—	—	—	—
F33T160GVP	3.00 x 3.00 x 60.00	76 x 76 x 1524	—	—	—	—	—	—	—	—
F33T1120GVP	3.00 x 3.00 x 120.00	76 x 76 x 3048	—	—	—	—	—	—	—	—
F44T112GVPWK	4.00 x 4.00 x 12.00	102 x 102 x 305	4	4	1.62	41	3.00	76	6.00	152
F44T112GVP	4.00 x 4.00 x 12.00	102 x 102 x 305	—	—	—	—	—	—	—	—
F44T118GVP	4.00 x 4.00 x 18.00	102 x 102 x 455	—	—	—	—	—	—	—	—
F44T124GVPWK	4.00 x 4.00 x 24.00	102 x 102 x 610	8	8	1.62	41	6.00	152	12.00	305
F44T124GVP	4.00 x 4.00 x 24.00	102 x 102 x 610	—	—	—	—	—	—	—	—
F44T136GVPWK	4.00 x 4.00 x 36.00	102 x 102 x 914	12	12	1.62	41	6.00	152	12.00	305
F44T136GVP	4.00 x 4.00 x 36.00	102 x 102 x 914	—	—	—	—	—	—	—	—
F44T148GVPWK	4.00 x 4.00 x 48.00	102 x 102 x 1219	16	16	1.62	41	6.00	152	12.00	305
F44T148GVP	4.00 x 4.00 x 48.00	102 x 102 x 1219	—	—	—	—	—	—	—	—
F44T160GVPWK	4.00 x 4.00 x 60.00	102 x 102 x 1524	20	20	1.62	41	6.00	152	12.00	305
F44T160GVP	4.00 x 4.00 x 60.00	102 x 102 x 1524	—	—	—	—	—	—	—	—
F44T172GVPWK	4.00 x 4.00 x 72.00	102 x 102 x 1829	24	24	1.62	41	6.00	152	12.00	305
F44T172GVP	4.00 x 4.00 x 72.00	102 x 102 x 1829	—	—	—	—	—	—	—	—
F44T1120GVPWK	4.00 x 4.00 x 120.00	102 x 102 x 3048	40	40	1.62	41	6.00	152	12.00	305
F44T1120GVP	4.00 x 4.00 x 120.00	102 x 102 x 3048	—	—	—	—	—	—	—	—
F66T112GVPWK	6.00 x 6.00 x 12.00	152 x 152 x 305	4	4	1.62	41	6.00	152	12.00	305
F66T112GVP	6.00 x 6.00 x 12.00	152 x 152 x 305	—	—	—	—	—	—	—	—
F66T118GVP	6.00 x 6.00 x 18.00	152 x 152 x 455	—	—	—	—	—	—	—	—
F66T124GVPWK	6.00 x 6.00 x 24.00	152 x 152 x 610	8	8	1.62	41	6.00	152	12.00	305
F66T124GVP	6.00 x 6.00 x 24.00	152 x 152 x 610	—	—	—	—	—	—	—	—
F66T136GVPWK	6.00 x 6.00 x 36.00	152 x 152 x 914	12	12	1.62	41	6.00	152	12.00	305
F66T136GVP	6.00 x 6.00 x 36.00	152 x 152 x 914	—	—	—	—	—	—	—	—
F66T148GVPWK	6.00 x 6.00 x 48.00	152 x 152 x 1219	16	16	1.62	41	6.00	152	12.00	305
F66T148GVP	6.00 x 6.00 x 48.00	152 x 152 x 1219	—	—	—	—	—	—	—	—
F66T160GVPWK	6.00 x 6.00 x 60.00	152 x 152 x 1524	20	20	1.62	41	6.00	152	12.00	305
F66T160GVP	6.00 x 6.00 x 60.00	152 x 152 x 1524	—	—	—	—	—	—	—	—
F66T172GVPWK	6.00 x 6.00 x 72.00	152 x 152 x 1829	24	24	1.62	41	6.00	152	12.00	305
F66T172GVP	6.00 x 6.00 x 72.00	152 x 152 x 1829	—	—	—	—	—	—	—	—
F66T1120GVPWK	6.00 x 6.00 x 120.00	152 x 152 x 3048	40	40	1.62	41	6.00	152	12.00	305
F66T1120GVP	6.00 x 6.00 x 120.00	152 x 152 x 3048	—	—	—	—	—	—	—	—
F88T112GVPWK	8.00 x 8.00 x 12.00	203 x 203 x 305	4	4	1.62	41	3.00	76	6.00	152
F88T112GVP	8.00 x 8.00 x 12.00	203 x 203 x 305	—	—	—	—	—	—	—	—
F88T118GVP	8.00 x 8.00 x 18.00	203 x 203 x 455	—	—	—	—	—	—	—	—
F88T124GVPWK	8.00 x 8.00 x 24.00	203 x 203 x 610	8	8	1.62	41	6.00	152	12.00	305
F88T124GVP	8.00 x 8.00 x 24.00	203 x 203 x 610	—	—	—	—	—	—	—	—
F88T136GVPWK	8.00 x 8.00 x 36.00	203 x 203 x 914	12	12	1.62	41	6.00	152	12.00	305
F88T136GVP	8.00 x 8.00 x 36.00	203 x 203 x 914	—	—	—	—	—	—	—	—
F88T148GVPWK	8.00 x 8.00 x 48.00	203 x 203 x 1219	16	16	1.62	41	6.00	152	12.00	305
F88T148GVP	8.00 x 8.00 x 48.00	203 x 203 x 1219	—	—	—	—	—	—	—	—
F88T160GVPWK	8.00 x 8.00 x 60.00	203 x 203 x 1524	20	20	1.62	41	6.00	152	12.00	305
F88T160GVP	8.00 x 8.00 x 60.00	203 x 203 x 1524	—	—	—	—	—	—	—	—
F88T172GVP	8.00 x 8.00 x 72.00	203 x 203 x 1829	—	—	—	—	—	—	—	—
F88T1120GVP	8.00 x 8.00 x 120.00	203 x 203 x 3048	—	—	—	—	—	—	—	—
F1010T112GVP	10.00 x 10.00 x 12.00	254 x 254 x 305	—	—	—	—	—	—	—	—
F1010T124GVP	10.00 x 10.00 x 24.00	254 x 254 x 610	—	—	—	—	—	—	—	—
F1010T136GVP	10.00 x 10.00 x 36.00	254 x 254 x 914	—	—	—	—	—	—	—	—
F1010T148GVP	10.00 x 10.00 x 48.00	254 x 254 x 1219	—	—	—	—	—	—	—	—
F1010T160GVP	10.00 x 10.00 x 60.00	254 x 254 x 1524	—	—	—	—	—	—	—	—
F1010T172GVP	10.00 x 10.00 x 72.00	254 x 254 x 1829	—	—	—	—	—	—	—	—
F1010T1120GVP	10.00 x 10.00 x 120.00	254 x 254 x 3048	—	—	—	—	—	—	—	—
F1212T112GVPWK	12.00 x 12.00 x 12.00	305 x 305 x 305	4	4	1.62	41	3.00	76	6.00	152
F1212T112GVP	12.00 x 12.00 x 12.00	305 x 305 x 305	—	—	—	—	—	—	—	—
F1212T124GVPWK	12.00 x 12.00 x 24.00	305 x 305 x 610	8	8	1.62	41	6.00	152	12.00	305
F1212T124GVP	12.00 x 12.00 x 24.00	305 x 305 x 610	—	—	—	—	—	—	—	—
F1212T136GVPWK	12.00 x 12.00 x 36.00	305 x 305 x 914	12	12	1.62	41	6.00	152	12.00	305
F1212T136GVP	12.00 x 12.00 x 36.00	305 x 305 x 914	—	—	—	—	—	—	—	—
F1212T148GVPWK	12.00 x 12.00 x 48.00	305 x 305 x 1219	16	16	1.62	41	6.00	152	12.00	305
F1212T148GVP	12.00 x 12.00 x 48.00	305 x 305 x 1219	—	—	—	—	—	—	—	—
F1212T160GVPWK	12.00 x 12.00 x 60.00	305 x 305 x 1524	20	20	1.62	41	6.00	152	12.00	305
F1212T160GVP	12.00 x 12.00 x 60.00	305 x 305 x 1524	—	—	—	—	—	—	—	—
F1212T1120GVP	12.00 x 12.00 x 120.00	305 x 305 x 3048	—	—	—	—	—	—	—	—

### 90-DEGREE FLUSH TEE

For flush mounting against a vertical or horizontal surface.

BULLETIN: F40PF

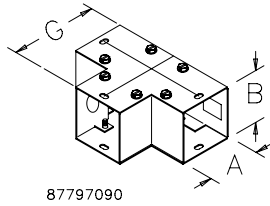

87797090

Catalog Number	AxB in./mm	G in./mm
F22GT	2.50 x 2.50 64 x 64	4.50 114
F33GT	3.00 x 3.00 76 x 76	5.00 127
F44GT	4.00 x 4.00 102 x 102	6.00 152
F66GT	6.00 x 6.00 152 x 152	8.00 203
F88GT	8.00 x 8.00 203 x 203	10.00 254
F1010GT	10.00 x 10.00 254 x 254	12.00 305
F1212GT	12.00 x 12.00 305 x 305	14.00 356

### SWEEP TEE

For large radius turns. Mounts against vertical or horizontal surfaces. Top and inside covers removable.

BULLETIN: F40PF

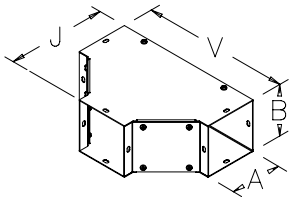

87574005

Catalog Number	AxB in./mm	J in./mm	V in./mm
F22T	2.50 x 2.50 64 x 64	6.50 165	10.35 263
F44T	4.00 x 4.00 102 x 102	8.00 203	11.85 301
F66T	6.00 x 6.00 152 x 152	10.00 254	13.85 352
F88T	8.00 x 8.00 203 x 203	12.00 305	15.84 402
F1010T	10.00 x 10.00 254 x 254	14.00 356	17.84 453
F1212T	12.00 x 12.00 305 x 305	16.00 406	19.84 504

### CROSS FITTING

For routing cables in four directions. Top, bottom and side covers removable.

BULLETIN: F40PF

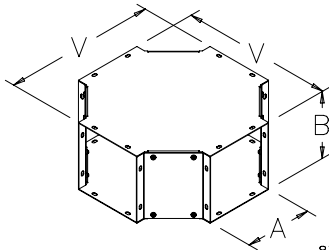

87574006

Catalog Number	AxB in./mm	V in./mm
F22X	2.50 x 2.50 64 x 64	10.35 263
F44X	4.00 x 4.00 102 x 102	11.85 301
F66X	6.00 x 6.00 152 x 152	13.85 352
F88X	8.00 x 8.00 203 x 203	15.84 402
F1010X	10.00 x 10.00 254 x 254	17.84 453
F1212X	12.00 x 12.00 305 x 305	19.84 504

### 90-DEGREE SWEEP ELBOW

For large radius turns.

BULLETIN: F40PF

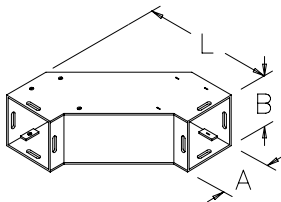

87797091

Catalog Number	AxB in./mm	L in./mm
F22G90SE	2.50 x 2.50 64 x 64	7.91 201
F44G90SE	4.00 x 4.00 102 x 102	9.41 239
F66G90SE	6.00 x 6.00 152 x 152	11.34 288
F88G90SE	8.00 x 8.00 203 x 203	13.44 341
F1010G90SE	10.00 x 10.00 254 x 254	15.62 395
F1212G90SE	12.00 x 12.00 305 x 305	17.44 443

### 90-DEGREE ELBOW-TEE-CROSS

Forms left or right 90-degree turns. Can be used as a tee or cross. Use with open adapter for cable entrance in top and bottom. Includes two closure plates.

BULLETIN: F40PF

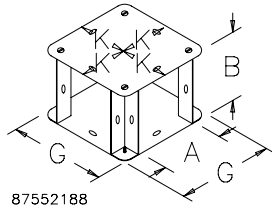

Catalog Number	AxB in./mm	G in./mm	K in./mm
F22G90TX	2.50 x 2.50 64 x 64	4.50 114	2.25 57
F33G90TX	3.00 x 3.00 76 x 76	5.00 127	2.50 64
F44G90TX	4.00 x 4.00 102 x 102	6.00 152	3.00 76
F66G90TX	6.00 x 6.00 152 x 152	8.00 203	4.00 102
F88G90TX	8.00 x 8.00 203 x 203	10.00 254	5.00 127
F1010G90TX	10.00 x 10.00 254 x 254	12.00 305	6.00 152
F1212G90TX	12.00 x 12.00 305 x 305	14.00 356	7.00 178

### 90-DEGREE ELBOW

Any side can be removed, retaining lay-in feature regardless of how the elbow is oriented. Sides are held together with screws.

BULLETIN: F40PF

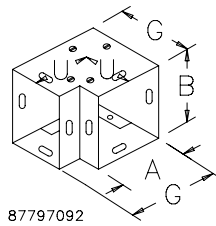

Catalog Number	AxB in./mm	G in./mm
F22G90E	2.50 x 2.50 64 x 64	4.50 114
F33G90E	3.00 x 3.00 76 x 76	5.00 127
F44G90E	4.00 x 4.00 102 x 102	6.00 152
F66G90E	6.00 x 6.00 152 x 152	8.00 203
F88G90E	8.00 x 8.00 203 x 203	10.00 254
F1010G90E	10.00 x 10.00 254 x 254	12.00 305
F1212G90E	12.00 x 12.00 305 x 305	14.00 356

### 90-DEGREE ELBOW—OUTSIDE OPENING

For continuous run with 90-degree turns. Top, bottom and outside covers removable.

BULLETIN: F40PF

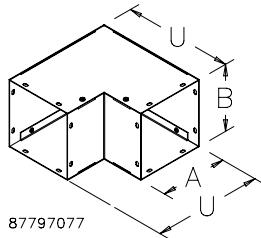

Catalog Number	AxB in./mm	U in./mm
F2290EOUT	2.50 x 2.50 64 x 64	6.50 165
F4490EOUT	4.00 x 4.00 102 x 102	8.00 203
F6690EOUT	6.00 x 6.00 152 x 152	10.00 254
F8890EOUT	8.00 x 8.00 203 x 203	12.00 305
F101090EOUT	10.00 x 10.00 254 x 254	14.00 356
F121290EOUT	12.00 x 12.00 305 x 305	16.00 406

### 90-DEGREE ELBOW—INSIDE OPENING

For continuous run with 90-degree turns. Top and inside covers removable.

BULLETIN: F40PF

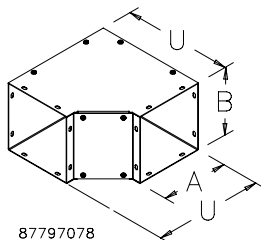

Catalog Number	AxB in./mm	U in./mm
F2290EIN	2.50 x 2.50 64 x 64	6.50 165
F4490EIN	4.00 x 4.00 102 x 102	8.00 203
F6690EIN	6.00 x 6.00 152 x 152	10.00 254
F8890EIN	8.00 x 8.00 203 x 203	12.00 305
F101090EIN	10.00 x 10.00 254 x 254	14.00 356
F121290EIN	12.00 x 12.00 305 x 305	16.00 406

### 45-DEGREE ELBOW

For continuous run with 45-degree turns. Top and inside covers removable.

BULLETIN: F40PF

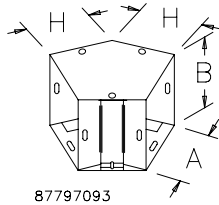

Catalog Number	AxB in./mm	H in./mm
F22G45E	2.50 x 2.50 64 x 64	2.75 70
F33G45E	3.00 x 3.00 76 x 76	2.99 76
F44G45E	4.00 x 4.00 102 x 102	3.38 86
F66G45E	6.00 x 6.00 152 x 152	4.25 108
F88G45E	8.00 x 8.00 203 x 203	5.06 129
F1010G45E	10.00 x 10.00 254 x 254	6.00 152
F1212G45E	12.00 x 12.00 305 x 305	6.75 171

### TELESCOPE FITTING

Length easily adjusts to approximately 12.00 in. (305 mm). No cutting or welding required.

BULLETIN: F40PF

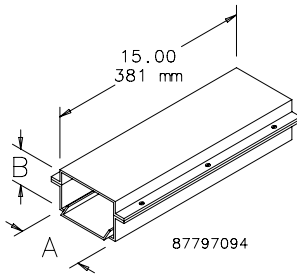

Catalog Number	AxB in./mm
F22GA	2.50 x 2.50 64 x 64
F44GA	4.00 x 4.00 102 x 102
F66GA	6.00 x 6.00 152 x 152
F88GA	8.00 x 8.00 203 x 203
F1010GA	10.00 x 10.00 254 x 254
F1212GA	12.00 x 12.00 305 x 305

These items not UL/cUL listed.

### OPEN ADAPTER

Used with the 90-Degree Elbow-Tee-Cross fitting to permit a run directly up or down.

BULLETIN: F40PF

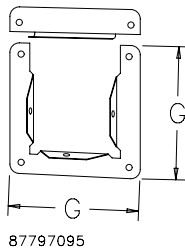

Catalog Number	G (in.)	G (mm)
F22GOA	4.50	114
F44GOA	6.00	152
F66GOA	8.00	203
F88GOA	10.00	254
F1010GOA	12.00	305
F1212GOA	14.00	356

### PANEL ADAPTER

A flanged fitting which allows the wireway to be securely connected to an enclosure.

BULLETIN: F40PF

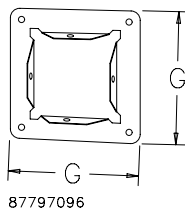

Catalog Number	G (in.)	G (mm)
F22GPA	4.50	114
F33GPA	5.00	127
F44GPA	6.00	152
F66GPA	8.00	203
F88GPA	10.00	254
F1010GPA	12.00	305
F1212GPA	14.00	356

### CLOSURE PLATE

Closes the end of a wireway section or run.

BULLETIN: F40PF

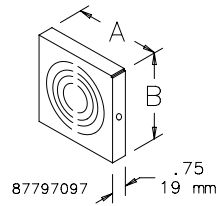

### DROP AND BRACKET HANGERS

Drop and bracket hangers support a wireway run.

BULLETIN: F40PF

Catalog Number	N max. (in.)	N max. (mm)	P (in.)	P (mm)	R (in.)	R (mm)	S (in.)	S (mm)	T (in.)	T (mm)
F22GDB	8.50	216	4.50	114	3.38	86	7.25	184	3.75	95
F44GDB	10.50	267	6.00	152	4.12	105	9.25	235	4.50	114
F66GDB	15.00	381	7.12	181	5.12	130	13.75	349	5.50	140
F88GDB	21.00	533	10.81	275	7.00	178	13.75	349	7.75	197
F1010GDB	22.00	559	13.81	335	8.38	213	13.75	349	10.25	260
F1212GDB	23.00	584	15.56	395	9.78	248	13.75	349	12.50	318

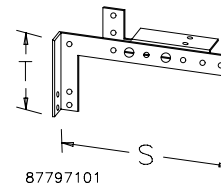
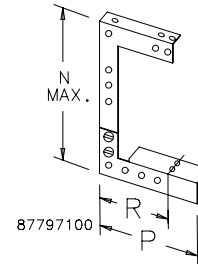

### SUPPORT HANGER

For floor or wall installations.

BULLETIN: F40PF

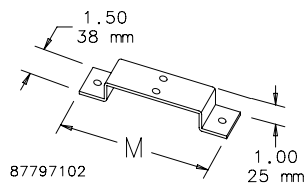

Catalog Number	AxB in.	AxB mm	Knockouts
F22GCP	2.50 x 2.50	64 x 64	With knockouts
F22GCPNK	2.50 x 2.50	64 x 64	Without knockouts
F44GCP	4.00 x 4.00	102 x 102	With knockouts
F33GCPNK	3.00 x 3.00	76 x 76	Without knockouts
F44GCPNK	4.00 x 4.00	102 x 102	Without knockouts
F66GCP	6.00 x 6.00	152 x 152	With knockouts
F66GCPNK	6.00 x 6.00	152 x 152	Without knockouts
F88GCP	8.00 x 8.00	203 x 203	With knockouts
F88GCPNK	8.00 x 8.00	203 x 203	Without knockouts
F1010GCP	10.00 x 10.00	254 x 254	With knockouts
F1010GCPNK	10.00 x 10.00	254 x 254	Without knockouts
F1212GCP	12.00 x 12.00	305 x 305	With knockouts
F1212GCPNK	12.00 x 12.00	305 x 305	Without knockouts

Catalog Number	AxB in./mm	M in./mm
F22GSH	2.50 x 2.50 64 x 64	4.62 117
F44GSH	4.00 x 4.00 102 x 102	6.12 155
F66GSH	6.00 x 6.00 152 x 152	8.12 206
F88GSH	8.00 x 8.00 203 x 203	10.12 257
F1010GSH	10.00 x 10.00 254 x 254	12.12 308
F1212GSH	12.00 x 12.00 305 x 305	14.12 359

### UNIVERSAL U-CONNECTOR

Joins wireway sections and fittings. Top swings aside to retain the lay-in feature. One U-connector required at each wireway joint except telescope fittings, panel adapters, open adapters, closure plates or reducers.

BULLETIN: F40PF

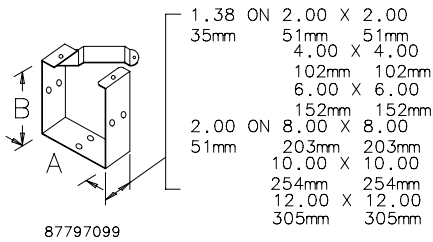

Catalog Number	AxB in./mm
F22GUC	2.50 x 2.50 64 x 64
F33GUC	3.00 x 3.00 76 x 76
F44GUC	4.00 x 4.00 102 x 102
F66GUC	6.00 x 6.00 152 x 152
F88GUC	8.00 x 8.00 203 x 203
F1010GUC	10.00 x 10.00 254 x 254
F1212GUC	12.00 x 12.00 305 x 305

### BARRIER KIT, BOLT-ON

Divides wireway into two or more compartments. Barriers are fastened to wireway sections with screws. Sealing washers are included.

BULLETIN: F20

Catalog Number	AxB in./mm	W in./mm
F33BK60	3.00 x 3.00 76 x 76	2.00 51
F44BK60	4.00 x 4.00 102 x 102	3.00 76
F66BK60	6.00 x 6.00 152 x 152	4.50 114
F88BK60	8.00 x 8.00 203 x 203	6.00 152

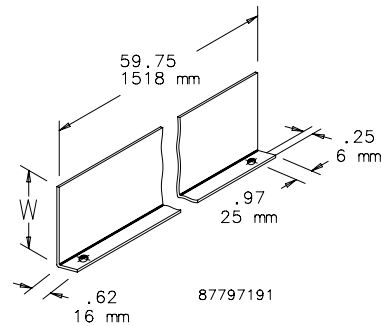

### REDUCER

Reduces wireway to a smaller size.

BULLETIN: F10, F40PF

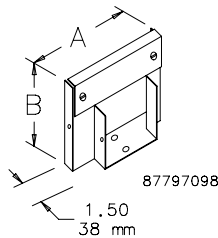

Catalog Number	AxB in./mm
F33G22R	3.00 x 3.00 76 x 76
F44G22R	4.00 x 4.00 102 x 102
F44G33R	4.00 x 4.00 101 x 101
F66G44R	6.00 x 6.00 152 x 152
F88G66R	8.00 x 8.00 203 x 203
F1010G88R	10.00 x 10.00 254 x 254
F1212G88R	12.00 x 12.00 305 x 305
F1212G1010R	12.00 x 12.00 305 x 305